



- ◆ PORTABLE POWER STATION
- ◆ SOLAR CHARGE CONTROLLER
- ◆ SOLAR INVERTER
- ◆ CAR INVERTER
- ◆ INVERTER
- ◆ BATTERY

GUANGDONG SUNRAY POWER CO.,LTD

+86 13923423419 +86 13332929246

www.gd-sumry.com www.sumry-cloud.com sumry@gdsunray.com

OFFICE:30/F, Block B, Building 1, Lefu Plaza, No.481 Guangming Avenue, Dongkeng Community, Fenghuang Street, Guangming District, Shenzhen

FACTORY:No. 5 Jiayu Road, Dongxing Area, Dongjiang Science and Technology Park, Zhongkai High tech Zone, Huizhou



Company website

VERSION:V20260319

广东三瑞电源有限公司
GUANGDONG SUNRAY POWER CO.,LTD



Huizhou Industrial Park
Huizhou plant area(61000M²)



R&D and sales center

ABOUT US

COMPANY PROFILE >>>>>

Guangdong Sunray Power Co., Ltd. is a national high-tech enterprise specializing in the research, design, production, sales, and service of photovoltaic and energy storage products. Its subsidiary brands include Shenzhen Sunray and Shenzhen Next power. Headquartered in Huizhou, the company's factory covers an area of 61,000 square meters. It has a 2000 square meter research and development center and sales center base in Shenzhen. With over 1,000 employees, its marketing and service network spans across more than 100 countries and regions worldwide.

Guangdong Sunray has a comprehensive research and quality assurance system, with main products including photovoltaic inverters, lithium batteries, uninterruptible power supplies, photovoltaic controllers, and photovoltaic energy storage inverters. These products are widely used in national defense, scientific research, communications, transportation new energy, and other fields. The products have obtained CE, VDE, SGS safety certifications, ISO9001 quality management system certification, as well as multiple invention patents, appearance design patents, utility model patents, and computer software copyrights.

In the Low-Carbon Age, Guangdong Sunray will continue to innovate in photovoltaic and energy storage technologies, providing products and solutions to customers.

Industry Experience
20⁺ yrs

Patents
800⁺ sum

Team Members
1000⁺ people

Installation Case
100⁺ countries or regions

Corporate Mission



Committed to become a global leading supplier of energy equipment and system solutions

Corporate Vision



Pursue the material and spiritual happiness of all partners

Core Values



University, effort, modesty, introspection, gratitude, altruism, optimism, innovation

Enterprise Spirit



Swift and resolute, truly practical and diligent

QUALIFICATIONS >>>>

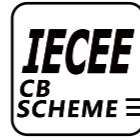
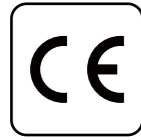

COMPANY HISTORY >>>>

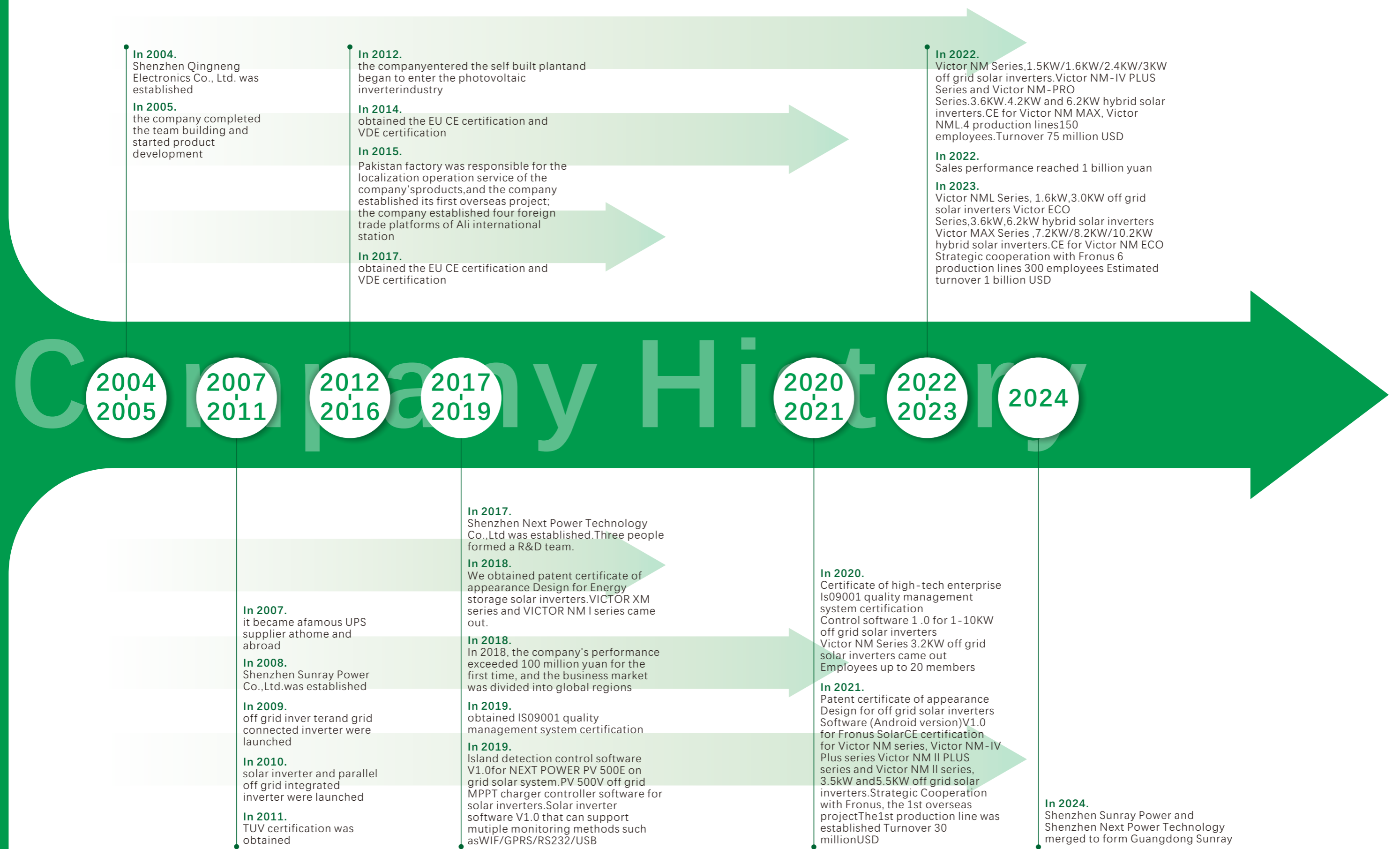

In 2004.
Shenzhen Qingneng Electronics Co., Ltd. was established

In 2005.
the company completed the team building and started product development

In 2012.
the company entered the self built plant and began to enter the photovoltaic inverter industry

In 2014.
obtained the EU CE certification and VDE certification

In 2015.
Pakistan factory was responsible for the localization operation service of the company's products, and the company established its first overseas project; the company established four foreign trade platforms of Ali international station

In 2017.
obtained the EU CE certification and VDE certification

In 2022.
Victor NM Series, 1.5KW/1.6KW/2.4KW/3KW off grid solar inverters. Victor NM-IV PLUS Series and Victor NM-PRO Series, 3.6KW, 4.2KW and 6.2KW hybrid solar inverters. CE for Victor NM MAX, Victor NML, 4 production lines, 150 employees. Turnover 75 million USD

In 2022.
Sales performance reached 1 billion yuan

In 2023.
Victor NML Series, 1.6kW, 3.0KW off grid solar inverters Victor ECO Series, 3.6kW, 6.2kW hybrid solar inverters Victor MAX Series, 7.2KW/8.2KW/10.2KW hybrid solar inverters. CE for Victor NM ECO Strategic cooperation with Fronus 6 production lines 300 employees Estimated turnover 1 billion USD

2004
2005

2007
2011

2012
2016

2017
2019

2020
2021

2022
2023

2024

In 2007.
it became a famous UPS supplier at home and abroad

In 2008.
Shenzhen Sunray Power Co., Ltd. was established

In 2009.
off grid inverter and grid connected inverter were launched

In 2010.
solar inverter and parallel off grid integrated inverter were launched

In 2011.
TUV certification was obtained

In 2017.
Shenzhen Next Power Technology Co., Ltd. was established. Three people formed a R&D team.

In 2018.
We obtained patent certificate of appearance Design for Energy storage solar inverters. VICTOR XM series and VICTOR NM I series came out.

In 2018.
In 2018, the company's performance exceeded 100 million yuan for the first time, and the business market was divided into global regions

In 2019.
obtained ISO9001 quality management system certification

In 2019.
Island detection control software V1.0 for NEXT POWER PV 500E on grid solar system. PV 500V off grid MPPT charger controller software for solar inverters. Solar inverter software V1.0 that can support multiple monitoring methods such as WiFi/GPRS/RS232/USB

In 2020.
Certificate of high-tech enterprise ISO9001 quality management system certification
Control software 1.0 for 1-10KW off grid solar inverters
Victor NM Series 3.2KW off grid solar inverters came out
Employees up to 20 members

In 2021.
Patent certificate of appearance Design for off grid solar inverters Software (Android version) V1.0 for Fronus Solar CE certification for Victor NM series, Victor NM-IV Plus series Victor NM II PLUS series and Victor NM II series, 3.5kW and 5.5KW off grid solar inverters. Strategic Cooperation with Fronus, the 1st overseas project The 1st production line was established Turnover 30 million USD

In 2024.
Shenzhen Sunray Power and Shenzhen Next Power Technology merged to form Guangdong Sunray

FACTORY >>>>

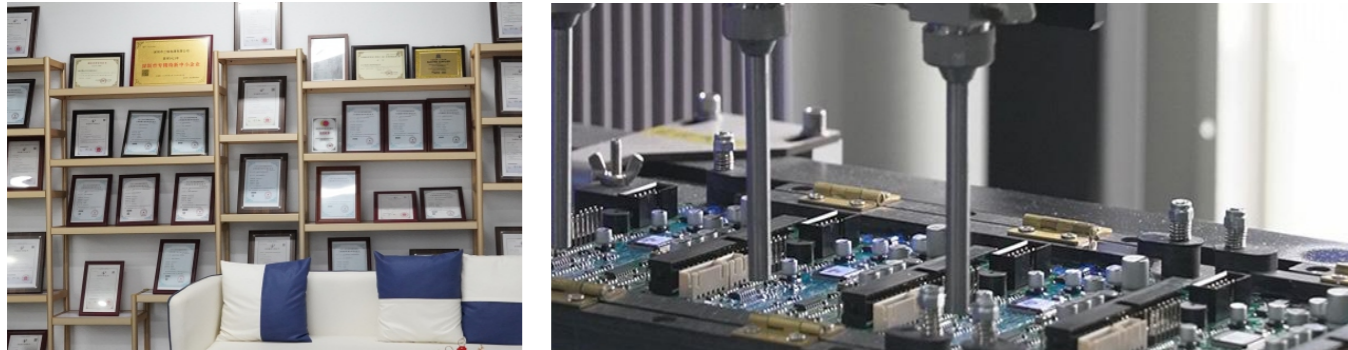

CAREFULLY CRAFTED

ABUNDANT INVENTORY



EXQUISITE WORKMANSHIP



CORE ADVANTAGES >>>>

MES System

Increase product traceability and monitor product quality throughout the entire process

Complete Processing Technology

Reduce outsourcing quality risks and meet the needs of customers in the photovoltaic industry

ONE STOP SERVICE

Provide one-stop services from complete machine production to overall design solutions for customers in the photovoltaic industry

High Quality Partners

Strategic cooperation with top equipment and material suppliers both domestically and internationally

Experienced R&D Team

More than 50 professional technical talents with over 20 years of experience in the photovoltaic industry have been dedicated to R&D and manufacturing for 20 years

Intelligent Manufacturing Enterprise

Production efficiency increased by 30%
Artificial reduction of 50%
Scrap reduced by 40%

Quick View Guide

SOLAR INVERTER

SPE 2.5-3.5KW

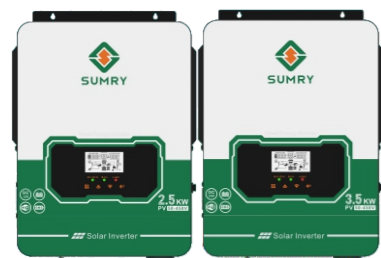

PAGE:11-12

SPE 4.2-6.2KW



PAGE:13-14

SPE 8.2-10.2KW



PAGE:15-16

SOLAR INVERTER

SEP SERIES

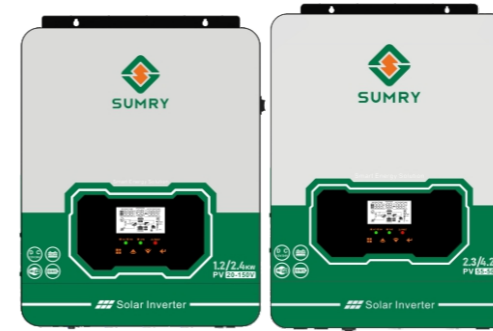

PAGE:23-28

SCE SERIES

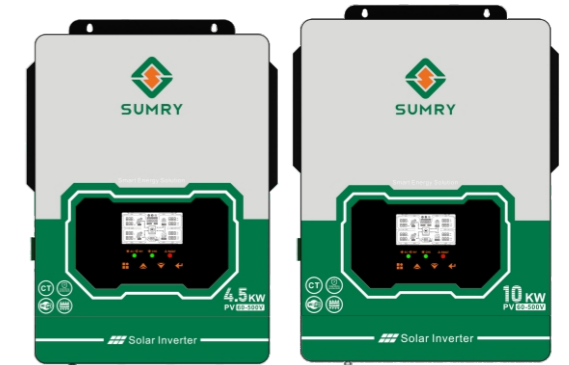

PAGE:29-30

SOLAR INVERTER

SPE-13.2KW



PAGE:17-18

SPE-M SERIES



PAGE:19-20

SPE-M PLUS SERIES



PAGE:21-22

SGE SERIES



PAGE:31-32

SGM SERIES



PAGE:33-34

SGP SERIES

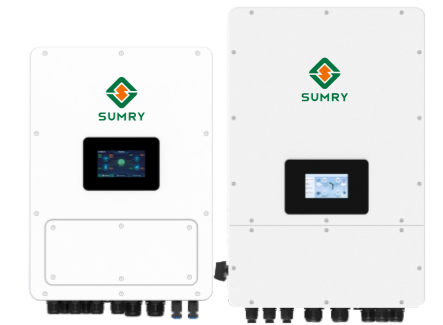

PAGE:35-38

SOLAR INVERTER

SPE SERIES



KEY STRENGTHS



FEATURES

- Pure sine wave solar inverter(on/off Grid)
- WIFI&GPRS available for iOS and Android
- Dual communication ports for Battery communication and Wifi communication
- High PV input voltage range(60~450VDC)
- Smart battery charge design to optimize battery life
- Offline upgrade through COMM port
- Inverter-lithium battery communication status displayed directly on the LCD interface
- Output power factor 1.0
- One-key restoration to factory Settings
- Built-in Lithium battery automatic activation
- Built-in MPPT Solar charge
- Built-in anti-dust kit for harsh environment
- Maximum PV input current: 18A
- Add lithium battery information display to the APP

MODEL	SPE-2.5KW	SPE-3.5KW
PHASE	Single phase	
Maximum PV Input Power	4000W	6000W
Rate Output Power	2500W/2500VA	3500W/3500VA
Grid-Tie OPERATION		
PV INPUT(DC)		
Nominal DC Voltage/Maximum DC Voltage	360VDC/500VDC	
Start-up Voltage/Initial Feeding Voltage	60VDC/90VDC	
MPPT Voltage Range	60~450VDC	
Maximum Input Current	18A	
EFFICIENCY		
Maximum Conversion Efficiency(DC-AC)	98%	
OFF-GRID, HYBRID OPERATION		
PV INPUT(DC)		
Maximum DC Voltage	60/500VDC	
Start-up Voltage/Initial Feeding Voltage	60VDC/90VDC	
MPP Voltage Range	60VDC-450VDC	
Number Of MPPT/Maximum Input Current	18A	18A
AC OUTPUT		
Nominal Output Voltage	220/230/240VAC	
Nominal Output Current	10A	14.3A
AC INPUT		
AC Start-up Voltage/Auto Restart Voltage	120-140VAC/180VAC	
AC Input Voltage Range	90-280VAC or 170-280VAC	
Maximum AC Input Current	15A	20A
BATTERY MODE OUTPUT(AC)		
Nominal Output Voltage	220/230/240VAC	
Efficiency	94%	
BATTERY & CHARGER		
Nominal Voltage	12VDC	24VDC
Maximum Solar Charging Current	100A	100A
Maximum AC Charging Current	80A	80A
Maximum Charging Current	100A	100A
GENERAL		
PHYSICAL		
Dimension, D*W*H(mm)	345×275×100	
Package Dimension, D*W*H(mm)	415×345×175	
INTERFACE		
Communication Port	RS232/RS485/WIFI/BMS	
ENVIRONMENT		
Operating Temperature	-10℃ ~ 50℃	

SOLAR INVERTER

SPE SERIES



KEY STRENGTHS



FEATURES

- Pure sine wave solar inverter(on/off Grid)
- WIFI&GPRS available for iOS and Android
- One-key restoration to factory Settings
- Dual communication ports for Battery communication and Wifi communication
- High PV input voltage range(60~450VDC)
- Smart battery charge design to optimize battery life
- Offline upgrade through COMM port
- Inverter-lithium battery communication status displayed directly on the LCD interface
- Add lithium battery information display to the APP
- Output power factor 1.0
- Inverter can run without battery
- Built-in Lithium battery automatic activation
- Built-in MPPT Solar charge
- Built-in anti-dust kit for harsh environment
- Dual output
- Maximum PV input current: 27A
- In battery-free mode, PV systems deliver a better user experience when powering loads

MODEL	SPE-4.2KW	SPE-6.2KW
PHASE	Single phase	
Maximum PV Input Power	6200W	8000W
Rate Output Power	4200W/4200VA	6200W/6200VA

Grid-Tie OPERATION		
PV INPUT(DC)		
Nominal DC Voltage/Maximum DC Voltage	360VDC/500VDC	
Start-up Voltage/Initial Feeding Voltage	60VDC/90VDC	
MPPT Voltage Range	60~450VDC	
Maximum Input Current	27A	
GRID OUTPUT(AC)		
Nominal Output Voltage	220/230/240VAC	
Output Voltage Range	195~253VAC	
Nominal Output Current	18.2A	27.0A
Power Factor	>0.99	
EFFICIENCY		
Maximum Conversion Efficiency(DC-AC)	98%	

OFF-GRID, HYBRID OPERATION		
PV INPUT(DC)		
Maximum DC Voltage	60/500VDC	
Start-up Voltage/Initial Feeding Voltage	60VDC/90VDC	
MPP Voltage Range	60VDC-450VDC	
Number Of MPPT/Maximum Input Current	27A	27A
GRID OUTPUT(AC)		
Nominal Output Voltage	220/230/240VAC	
Output Voltage Range	195~253VAC	
Nominal Output Current	18.2A	27.0A
AC INPUT		
AC Start-up Voltage/Auto Restart Voltage	120-140VAC/180VAC	
AC Input Voltage Range	90-280VAC or 170-280VAC	
Maximum AC Input Current	24.7A	36.4A
BATTERY MODE OUTPUT(AC)		
Nominal Output Voltage	220/230/240VAC	
Efficiency	94%	
BATTERY & CHARGER		
Nominal Voltage	24VDC	48VDC
Maximum Solar Charging Current	120A	120A
Maximum AC Charging Current	100A	100A
Maximum Charging Current	120A	120A

GENERAL		
PHYSICAL		
Dimension, D*W*H(mm)	423x344x113	
Package Dimension, D*W*H(mm)	500*415*180	
INTERFACE		
Communication Port	RS232/RS485/WIFI/BMS	
ENVIRONMENT		
Operating Temperature	-10°C ~ 50°C	

SOLAR INVERTER

SPE SERIES



KEY STRENGTHS



FEATURES

- Pure sine wave solar inverter(on/off Grid)
- Inverter can run without battery
- Built-in Lithium battery automatic activation
- Dual communication ports for Battery communication and Wifi communication
- Smart battery charge design to optimize battery life
- Dual PV input
- WIFI&GPRS available for IOS and Android
- One-key restoration to factory Settings
- Built-in 160A MPPT solar charger(for 8.2kw,10.2kw)
- Built-in anti-dust kit for harsh environment
- Dual output
- On Off Grid Work Mode

MODEL	SPE-8.2KW	SPE-10.2KW
PHASE	Single phase	
Maximum PV Input Power	5400W+5400W	
Rate Output Power	8200W/8200VA	10200W/10200VA
Grid-Tie OPERATION		
PV INPUT(DC)		
Nominal DC Voltage/Maximum DC Voltage	360VDC/500VDC	
Start-up Voltage/Initial Feeding Voltage	90VDC/120VDC	
MPPT Voltage Range	90~450VDC	
Maximum Input Current	2/18A	
GRID OUTPUT(AC)		
Nominal Output Voltage	220/230/240VAC	
Output Voltage Range	195~253VAC	
Nominal Output Current	35.6A	44.3A
Power Factor	>0.99	
EFFICIENCY		
Maximum Conversion Efficiency(DC-AC)	98%	
OFF-GRID, HYBRID OPERATION		
PV INPUT(DC)		
Maximum DC Voltage	500VDC	
Start-up Voltage/Initial Feeding Voltage	90VDC/120VDC	
MPP Voltage Range	90VDC-450VDC	
Number Of MPPT/Maximum Input Current	2/18A	
GRID OUTPUT(AC)		
Nominal Output Voltage	220/230/240VAC	
Output Voltage Range	195~253VAC	
Nominal Output Current	35.6A	44.3A
AC INPUT		
AC Start-up Voltage/Auto Restart Voltage	120-140VAC/180VAC	
AC Input Voltage Range	90-280VAC or 170-280VAC	
Maximum AC Input Current	48.2A	60A
BATTERY MODE OUTPUT(AC)		
Nominal Output Voltage	220/230/240VAC	
Efficiency	94%	
BATTERY & CHARGER		
Nominal Voltage	48VDC	
Maximum Solar Charging Current	160A	
Maximum AC Charging Current	140A	
Maximum Charging Current	160A	
GENERAL		
PHYSICAL		
Dimension,D*W*H(mm)	500*390*136	
Package Dimension,D*W*H(mm)	588*463*205	
INTERFACE		
Communication Port	RS232/RS485/WIFI/BMS	
ENVIRONMENT		
Operating Temperature	-10 °C ~ 50°C	

SOLAR INVERTER

SPE SERIES



KEY STRENGTHS



FEATURES

- | Pure sine wave solar inverter(on/off Grid)
- | Inverter can run without battery
- | Built-in Lithium battery automatic activation
- | Dual communication ports for Battery communication and Wifi communication
- | Smart battery charge design to optimize battery life
- | Dual PV input
- | WIFI&GPRS available for IOS and Android
- | One-key restoration to factory Settings
- | Built-in 160A MPPT solar charger(for13.2kw)
- | Built-in anti-dust kit for harsh environment
- | Dual output
- | On Off Grid Work Mode

MODEL	SPE-13.2KW
PHASE	Single phase
Maximum PV Input Power	8000W+8000W
Rate Output Power	13200W/13200VA
Grid-Tie OPERATION	
PV INPUT(DC)	
Nominal DC Voltage/Maximum DC Voltage	360VDC/500VDC
Start-up Voltage/Initial Feeding Voltage	90VDC/120VDC
MPPT Voltage Range	90~450VDC
Maximum Input Current	2/22A
GRID OUTPUT(AC)	
Nominal Output Voltage	220/230/240VAC
Output Voltage Range	195~253VAC
Nominal Output Current	57.3A
Power Factor	>0.99
EFFICIENCY	
Maximum Conversion Efficiency(DC-AC)	98%
OFF-GRID, HYBRID OPERATION	
PV INPUT(DC)	
Maximum DC Voltage	500VDC
Start-up Voltage/Initial Feeding Voltage	90VDC/120VDC
MPP Voltage Range	90VDC-450VDC
Number Of MPPT/Maximum Input Current	2/22A
GRID OUTPUT(AC)	
Nominal Output Voltage	220/230/240VAC
Output Voltage Range	195~253VAC
Nominal Output Current	57.3A
AC INPUT	
AC Start-up Voltage/Auto Restart Voltage	120-140VAC/180VAC
AC Input Voltage Range	90-280VAC or 170-280VAC
Maximum AC Input Current	80A
BATTERY MODE OUTPUT(AC)	
Nominal Output Voltage	220/230/240VAC
Efficiency	94%
BATTERY & CHARGER	
Nominal Voltage	48VDC
Maximum Solar Charging Current	160A
Maximum AC Charging Current	140A
Maximum Charging Current	160A
GENERAL	
PHYSICAL	
Dimension, D*W*H(mm)	580*370*136
Package Dimension, D*W*H(mm)	650*460*205
INTERFACE	
Communication Port	RS232/RS485/WIFI/BMS
ENVIRONMENT	
Operating Temperature	-10 °C ~ 50°C

SOLAR INVERTER

SPE-M SERIES



KEY STRENGTHS



FEATURES

- Pure sine wave solar inverter(on/off Grid)
- Standard WIFI Module, compatible with Android and iOS
- One-key restoration to factory Settings
- Dual communication ports for Battery communication and Wifi communication
- High PV input voltage range(60~450VDC)
- Smart battery charge design to optimize battery life
- Offline upgrade through COMM port
- Inverter-lithium battery communication status displayed directly on the LCD interface
- Add lithium battery information display to the APP
- Output power factor 1.0
- Inverter can run without battery
- Built-in Lithium battery automatic activation
- Built-in MPPT Solar charge
- Built-in anti-dust kit for harsh environment
- Dual output
- Maximum PV input current: 27A
- In battery-free mode, PV systems deliver a better user experience when powering loads
- The screen is movable and supports an expansion of up to 100 meters.

MODEL	SPE-M-4.2KW	SPE-M-6.2KW
PHASE	Single phase	
Maximum PV Input Power	6200W	8000W
Rate Output Power	4200W/4200VA	6200W/6200VA
Grid-Tie OPERATION		
PV INPUT(DC)		
Nominal DC Voltage/Maximum DC Voltage	360VDC/500VDC	
Start-up Voltage/Initial Feeding Voltage	60VDC/90VDC	
MPPT Voltage Range	60~450VDC	
Maximum Input Current	27A	
GRID OUTPUT(AC)		
Nominal Output Voltage	220/230/240VAC	
Output Voltage Range	195~253VAC	
Nominal Output Current	18.2A	27.0A
Power Factor	>0.99	
EFFICIENCY		
Maximum Conversion Efficiency(DC-AC)	98%	
OFF-GRID, HYBRID OPERATION		
PV INPUT(DC)		
Maximum DC Voltage	500VDC	
Start-up Voltage/Initial Feeding Voltage	60VDC/90VDC	
MPP Voltage Range	60VDC-450VDC	
Number Of MPPT/Maximum Input Current	27A	27A
GRID OUTPUT(AC)		
Nominal Output Voltage	220/230/240VAC	
Output Voltage Range	195~253VAC	
Nominal Output Current	18.2A	27.0A
AC INPUT		
AC Start-up Voltage/Auto Restart Voltage	120-140VAC/180VAC	
AC Input Voltage Range	90-280VAC or 170-280VAC	
Maximum AC Input Current	24.7A	36.4A
BATTERY MODE OUTPUT(AC)		
Nominal Output Voltage	220/230/240VAC	
Efficiency	94%	
BATTERY & CHARGER		
Nominal Voltage	24VDC	48VDC
Maximum Solar Charging Current	120A	120A
Maximum AC Charging Current	100A	100A
Maximum Charging Current	120A	120A
GENERAL		
PHYSICAL		
Dimension, D*W*H(mm)	423*344*148	
Package Dimension, D*W*H(mm)	500*415*215	
INTERFACE		
Communication Port	RS232/RS485/WIFI/BMS	
ENVIRONMENT		
Operating Temperature	-10°C ~ 50°C	

SOLAR INVERTER

SPE-M PLUS SERIES



KEY STRENGTHS



FEATURES

- Pure sine wave solar inverter(on/off Grid)
- Standard WIFI Module, compatible with Android and iOS
- One-key restoration to factory Settings
- Dual communication ports for Battery communication and Wifi communication
- High PV input voltage range(60~450VDC)
- Smart battery charge design to optimize battery life
- Offline upgrade through COMM port
- Inverter-lithium battery communication status displayed directly on the LCD interface
- Add lithium battery information display to the APP
- Under the battery's rated voltage and an ambient temperature of 40°C, with full-power output
- Output power factor 1.0
- Inverter can run without battery
- Built-in Lithium battery automatic activation
- Built-in MPPT Solar charge
- Built-in anti-dust kit for harsh environment
- Dual output
- Maximum PV input current: 27A
- In battery-free mode, PV systems deliver a better user experience when powering loads
- The screen is movable and supports an expansion of up to 100 meters.

MODEL	SPE-M PLUS-4.6KW	SPE-M PLUS-6.6KW
PHASE	Single phase	
Maximum PV Input Power	7200W	8000W
Rate Output Power	4600W/4600VA	6600W/6600VA
Grid-Tie OPERATION		
PV INPUT(DC)		
Nominal DC Voltage/Maximum DC Voltage	360VDC/500VDC	
Start-up Voltage/Initial Feeding Voltage	60VDC/90VDC	
MPPT Voltage Range	60~450VDC	
Maximum Input Current	27A	
GRID OUTPUT(AC)		
Nominal Output Voltage	220/230/240VAC	
Output Voltage Range	195~253VAC	
Nominal Output Current	20A	28.69A
Power Factor	>0.99	
EFFICIENCY		
Maximum Conversion Efficiency(DC-AC)	98%	
OFF-GRID, HYBRID OPERATION		
PV INPUT(DC)		
Maximum DC Voltage	500VDC	
Start-up Voltage/Initial Feeding Voltage	60VDC/90VDC	
MPP Voltage Range	60VDC-450VDC	
Number Of MPPT/Maximum Input Current	27A	27A
GRID OUTPUT(AC)		
Nominal Output Voltage	220/230/240VAC	
Output Voltage Range	195~253VAC	
Nominal Output Current	20A	28.69A
AC INPUT		
AC Start-up Voltage/Auto Restart Voltage	120-140VAC/180VAC	
AC Input Voltage Range	90-280VAC or 170-280VAC	
Maximum AC Input Current	30A	40A
BATTERY MODE OUTPUT(AC)		
Nominal Output Voltage	220/230/240VAC	
Efficiency	94%	
BATTERY & CHARGER		
Nominal Voltage	24VDC	48VDC
Maximum Solar Charging Current	120A	120A
Maximum AC Charging Current	100A	100A
Maximum Charging Current	120A	120A
GENERAL		
PHYSICAL		
Dimension, D*W*H(mm)	461×320×139	
Package Dimension, D*W*H(mm)	610×410×235	
INTERFACE		
Communication Port	RS232/RS485/WIFI/BMS	
ENVIRONMENT		
Operating Temperature	-10°C ~ 50°C	

SOLAR INVERTER

SEP-2400L



KEY STRENGTHS



FEATURES

- | Work at 2 different voltages : 12VDC or 24VDC. It can meet different loads needs of users
- | Dual use on one inverter--World's first creation in 2025
- | According to the requirements of load,the input voltage range of utility grid can be selected
- | Solar energy and utility grid can power loads at the same time
- | Automatic restart function when mains power is restored
- | The intelligent charging design of battery makes the battery more fully utilized
- | Cold start function
- | Pure sine wave output inverter
- | According to the battery requirements, the charging current can be set through LCD
- | AC input is compatible with mains and generator
- | Overload/Overtemperature/ short circuit protection
- | RGB lights (optional)

MODEL	SEP-2400L	
BATTERY	12VDC	24VDC
PHASE	Single phase	
Maximum PV Input Power	600W	1200W
Rate Output Power	1200VA/1200W	2400VA/2400W
OFF-GRID		
PV INPUT(DC)		
Maximum DC Voltage	150VDC	
Start-up Voltage	20VDC	30VDC
MPP Voltage Range	20VDC-150VDC	30VDC-150VDC
GRID OUTPUT(AC)		
Nominal Output Voltage	230VAC	
AC INPUT		
AC Start-upVoltage/Auto Restart Voltage	90VAC/80VAC	
AC Input Voltage Range	90VAC ~ 280VAC	
Maximum AC Input Current	30A	
BATTERY MODE OUTPUT(AC)		
Nominal Output Voltage	230VAC	
Efficiency	94%	
BATTERY & CHARGER		
DC Voltage Range/Nominal Voltage	10VDC ~ 16VDC/12VDC	20VDC ~ 32VDC/24VDC
Maximum Solar Charging Current	40A	
Maximum AC Charging Current	60A	
Maximum Charging Current	100A	
GENERAL		
PHYSICAL		
Dimension,D*W*H(mm)	360*275*84.7	
Net Weight (kgs)	5.0	
INTERFACE		
Communication Port	RS232/RS485/WIFI/BMS	
ENVIRONMENT		
Operating Temperature	-20°C ~ 50°C	
STANDARD		
Safety	CE:IEC-62109	

DUAL USE ON ONE INVERTER

SEP2400L is working at 2 voltages and carrying different loads

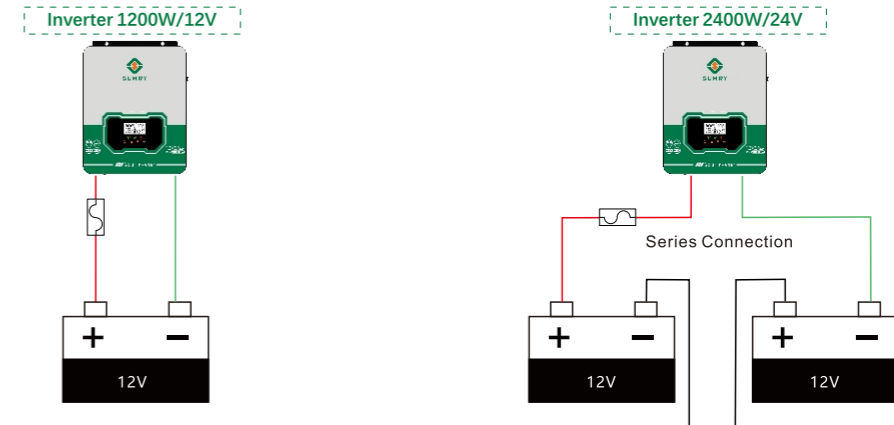

Freely match 12VDC or 24VDC according to user needs(The maximum load is 1200W for 12v battery can carry,and the maximum load is 2400W for 24V battery can carry)

SOLAR INVERTER

SEP-4200H



KEY STRENGTHS



FEATURES

- | Work at 2 different voltages : 12VDC or 24VDC. It can meet different loads needs of users
- | Dual use on one inverter--World's first creation in 2025
- | According to the requirements of load,the input voltage range of utility grid can be selected
- | Solar energy and utility grid can power loads at the same time
- | Automatic restart function when mains power is restored
- | The intelligent charging design of battery makes the battery more fully utilized
- | Cold start function
- | Pure sine wave output inverter
- | According to the battery requirements, the charging current can be set through LCD
- | AC input is compatible with mains and generator
- | Overload/Overtemperature/ short circuit protection
- | RGB lights (optional)

MODEL	SEP-4200H	
Battery Voltage	12V	24V
Rated output power	2300VA/2300W	4200VA/4200W
Input	230VAC	
Voltage	170~280VAC(For Personal Computers)	
Selectable Voltage Range	90~280VAC(For Home Appliances)	
Frequency Range	50Hz/60Hz(Auto Sensing)	
OUTPUT		
AC Voltage Regulation(Batt.Mode)	230VAC ±5%	
Surge Power	4600W	8400W
Efficiency(peak)Battery to INV	94%	
Transfer Time	10ms(For Personal Computers);20ms(For Home Appliances)	
BATTERY&AC CHARGE		
Battery Voltage	12V	24V
Floating Charge Voltage	13.5V	27VDC
Overcharge Protection	16 Vdc	32Vdc
Maximum Charge Current	100A	
SOLAR CHARGE		
Maximum PV Array Power	4000W	
MPPT Range @Operating Voltage	55~500VDC	
Maximum PV Array Open Circuit Voltage	500VDC	
Maximum Charge Current	100A	
PHYSICAL		
Dimension D*W*H(mm)	480*400*200	
Net Weight(kgs)	8.0	
Communication interface	RS485/RS232/ BMS/WIFI/Bluetooth	
OPERATING ENVIRONMENT		
Humidity	5%to 95%Relative Humidity(Non- condensing)	
Operating Temperature	-20°C~55°C	
Storage Temperature	-20°C~60°C	

DUAL USE ON ONE INVERTER

SEP4200H is working at 2 voltages and carrying different loads

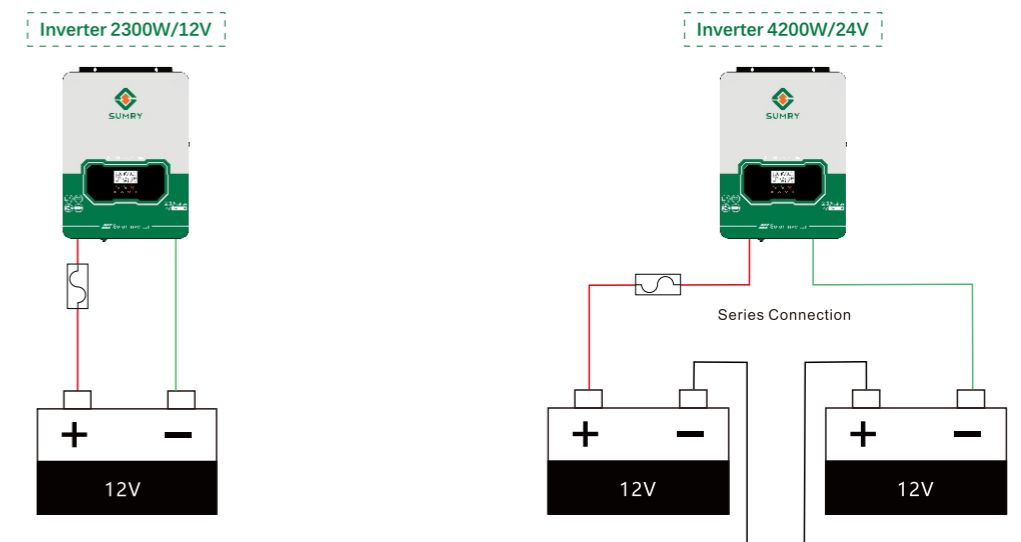

Freely match 12VDC or 24VDC according to user needs(The maximum load is 2300W for 12v battery can carry, and the maximum load is 4200W for 24V battery can carry)

SOLAR INVERTER

SEP-4200 PRO



KEY STRENGTHS



FEATURES

- | Work at 2 different voltages : 12VDC or 24VDC. It can meet different loads needs of users
- | Dual use on one inverter -- World's first creation in 2025
- | According to the requirements of load, the input voltage range of utility grid can be selected
- | Solar energy and utility grid can power loads at the same time
- | Automatic restart function when mains power is restored
- | The intelligent charging design of battery makes the battery more fully utilized
- | Grid connection function
- | Lithium battery activation function
- | Cold start function
- | Pure sine wave output inverter
- | According to the battery requirements, the charging current can be set through LCD
- | AC input is compatible with mains and generator
- | Overload/Overtemperature/ short circuit protection
- | RGB lights (optional)
- | Machines can work without batteries
- | Intelligent speed regulation of fan

MODEL	SEP-4200 PRO	
Battery Voltage	12V	24V
Rated output power	2300VA/2300W	4200VA/4200W
Input	230VAC	
Voltage	170~280VAC(For Personal Computers)	
Selectable Voltage Range	90~280VAC(For Home Appliances)	
Frequency Range	50Hz/60Hz(Auto Sensing)	
OUTPUT		
AC Voltage Regulation(Batt.Mode)	230VAC ±5%	
Surge Power	4600W	8400W
Efficiency(peak)Battery to INV	94%	
Transfer Time	10ms(For Personal Computers);20ms(For Home Appliances)	
BATTERY&AC CHARGE		
Battery Voltage	12V	24V
Floating Charge Voltage	13.5V	27VDC
Overcharge Protection	16 Vdc	32Vdc
Maximum Charge Current	100A	
SOLAR CHARGE		
Maximum PV Array Power	6000W	
MPPT Range @Operating Voltage	55~500VDC	
Maximum PV Array Open Circuit Voltage	500VDC	
Maximum Charge Current	100A	
PHYSICAL		
Dimension D*W*H(mm)	480*400*200	
Net Weight(kgs)	8.0	
Communication interface	RS485/RS232/ BMS/WIFI/Bluetooth	
OPERATING ENVIRONMENT		
Humidity	5%to 95%Relative Humidity(Non- condensing)	
Operating Temperature	-20°C~55°C	
Storage Temperature	-20°C~60°C	

DUAL USE ON ONE INVERTER

SEP4200 PRO is working at 2 voltages and carrying different loads

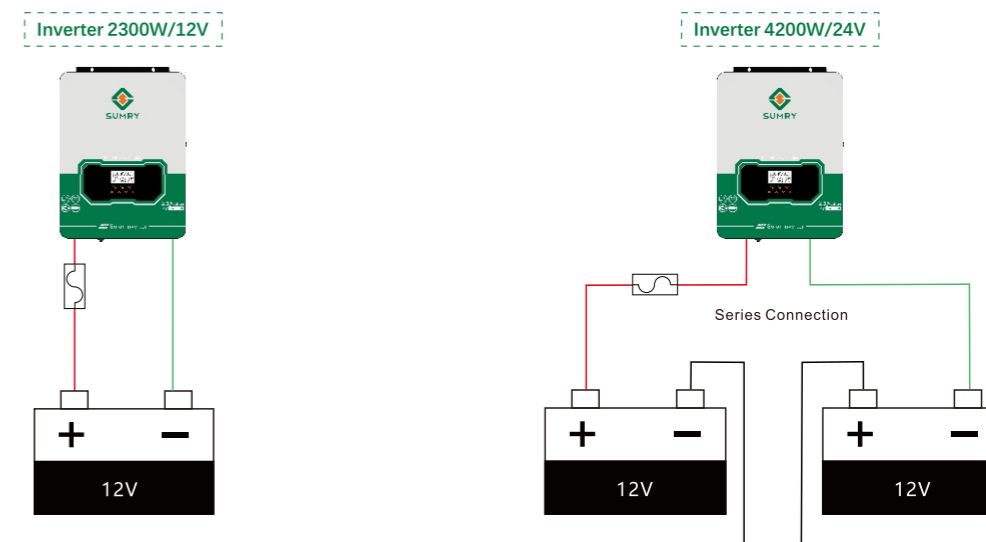

Freely match 12VDC or 24VDC according to user needs(The maximum load is 2300W for 12v battery can carry, and the maximum load is 4200W for 24V battery can carry)

SOLAR INVERTER

SCE SERIES



KEY STRENGTHS



FEATURES

- Pure sine wave solar inverter
- Build in high efficiency MPPT solar controller
- Dual MPPT solar controller for different groups solar panel
- Build in feedback detection current sensor
- Fast islanding response ensures security
- Can work in on/off grid mode
- Wide PV input voltage range:60-500VDC
- LCD display all information on one interface
- Communication interface for Wifi
- Easy to replace dust screen design



MODEL	SCE3604K5SG2	SCE3606K5SG2	SCE36010K0SG2
Phase	Single-phase		
Rated Output Power	4.5KW/4.5KVA	6.5KW/6.5KVA	10KW/10KVA
PV MODE			
Number of MPPT	1	2	2
Maximum PV Input Power	6000W	6000W+6000W	6000W+6000W
Maximum PV Input Current	18A	18A+18A	
PV Array Maximum Open Circuit Voltage	500VDC		
PV Input Voltage Range	60-500VDC		
Start Up Voltage	120VDC		
Nominal DC Voltage	360VDC		
MPPT Trackers Efficiency	>99.5%		
LINE MODE			
Phase	Single-phase		
Voltage	230VAC		
Input Voltage Range	90-280VAC		
Input Frequency Range	40-65Hz		
Maximum Input Current	30A	30A	45A
Input Power Factor	>0.99		
Input THDi	<5%		
PROTECTION			
Full Protection	Overload,short circuit,over-temperature,over-current,anti-islanding protection		
PHYSICAL			
Dimension H*W*D(mm)	315*225*103	335*245*103	
Net Weight(kgs)	4.1	4.5	4.9
Gross Weight(kgs)	4.8	5.2	5.6
IP Protection	IP20		
INTERFACE			
Communication Port	RS-232		
ENVIRONMENT			
Humidity	<95%RH(Non-condensing)		
Operating Temperature	-10°C to 55°C		

OVERVIEW

◆ 4.5KW

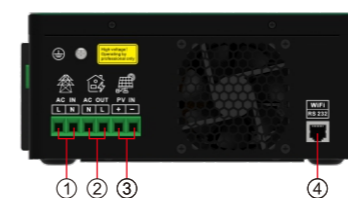

1. AC Input
2. AC Output
3. PV Input
4. RS232/Wifi

◆ 6.5KW/10KW

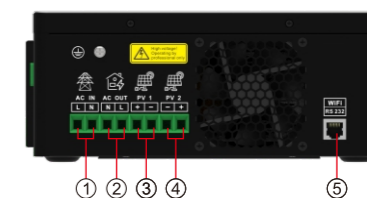

1. AC Input
2. AC Output
3. PV 1
4. PV 2
5. RS232/Wifi

SOLAR INVERTER

SGE SERIES



KEY STRENGTHS



FEATURES

- High Efficiency & Smaller: Inverter/charging efficiency up to 95.5% (mainstream $\leq 93\%$), 30% smaller, low heat for longer life
- Smart Dual Outputs: Manages critical and general loads; custom 2nd output switch time & power-off voltage
- Smart Lithium Battery Mgmt: Activates protected batteries; adjusts charging curve by power to optimize charging
- Parallel Operation: Up to 9 units parallel; compatible with 3-phase/single-phase
- Smart Noise Control: Long-life fan (35-50dB); balances heat dissipation & quietness
- Standard broken-code LCD (current standard); optional 4.3-inch capacitive touch display
- Dustproof net: replaceable, washable; humanized cleaning cycle reminder
- Supports wireless upgrade (no network needed) for personalized customization
- Utility/PV self-start: Auto-starts when utility/PV connected (no manual restart after low-voltage battery shutdown)
- Recommended altitude $\leq 2000\text{m}$ (derated use at 2000m)
- Dual-CPU control, dual safety protection, built-in Gateway network module
- AC dual-input: One for mains power, one for generator dedicated interface
- Microgrid anti-backflow (optional): External CT + current sensor enables self-consumption, reducing wiring work
- Battery-Free Operation: Works with PV or mains power
- The optional WIFI module, support links SUNRAY Cloud for anytime/anywhere energy management & monitoring
- Bluetooth Direct Connect: Check device status via phone without network
- Standard 2 independent PV inputs; each MPPT tracking efficiency $>99.5\%$
- Battery communication: customizable protocol; supports RS485/CAN, lithium/lead-acid batteries
- Optimal operating temp: 25°C; max: 65°C (derated above 45°C)
- Smart fan control: reduces noise/air intake, extends dustproof net & device service life
- Max noise $<50\text{dB}$; $<40\text{dB}$ at night

MODEL	SGE244K5SH2(ES)	SGE486K5SH2(ES)	SGE486K5SH2	SGE489K0SH2	SGE4812K0SH2
Rated Output Power	4.5kw	6.5kw		9kw	12kw
Rated Output Current	19.6A	28.5A		39.2A	52A
Input Mode	Single phase				
Input Voltage Range	170~280Vac				
Maximum AC Current Input	32A	40A	40A	55A	65A
Change-over Time	10ms (narrow range), 20ms (wide range)				
Input Power Factor	> 0.99 > 0.9				
BATTERY MODE					
Output Voltage	220/230 ± 5 (Vac)				
Battery Discharge Current	160A	140A	140A	190A	230A
Battery Charging Current	160A	140A	140A	190A	230A
Battery Input Range	20-30 (VDC)	40-60 (VDC)			
Overvoltage Protection	32VDC 63VDC				
Battery Discharge Conversion Efficiency	94.5%	95.20%		95.20%	
Battery Charging Conversion Efficiency	95%	95.20%		95.20%	
Overload	110%-125% 1min 125% -150% 30S $> 150\%$ 1S				
Battery Type	Lead-acid batteries, lithium batteries, flooded lead-acid battery, user customization				
Dual-port Output	The second load can be set to start and stop mode: 1. User-defined battery voltage for shutdown and startup 2. Users can define the time interval to start and stop				
Peak Coefficient Of Output Current	1: 3				
Parallel Current Sharing	Not support		Imbalance $<2\%$		
MPPT INPUT					
MPPT Quantity	1		1+1		
Maximum PV Input Current	24A	24A	18A+18A	18A+18A	18A+18A
Maximum PV Input Power	6kw	8.5kw	10kw	12kw	14.5kw
MPPT Starting Voltage	120VDC				
PV Input Voltage Range	60-500 (VDC)				
PV Best Input Voltage	360VDC				
MPPT Maximum Efficiency	99.5%				
European Efficiency	97%	97.3%		97.50%	
PV Priority Supply	Priority charging				
PROTECTIVE FUNCTION					
Input Overvoltage Protection	280Vac				
Input Overvoltage Protection Recovery	270Vac				
Input Under-voltage Protection	90Vac (narrow range); 170Vac (wide range)				
Input Under-voltage Protection Recovery	100Vac (narrow range); 180Vac (wide range)				
Output Short Circuit Protection	5 power frequency cycles				
Fan Fault Protection	Fan fault protection function. When any fan is faulty, the power module has no output.				
COMMUNICATION FUNCTIONS					
PROJECT			REMARKS		
Lithium Battery	One RS485;		One RS485; one CAN (optional)		
WiFi/host Computer	No built-in WiFi, external WiFi module supported		Built-in WiFi and Bluetooth modules, RS232;		
Parallel Operation	Not support		CAN, up to nine units in parallel		
Remote Control	Not support		Bluetooth (for near-range inverter data setup & viewing, no network required)		
OTHER					
Battery-free Mode	Compatible with lithium battery activation and no battery use				
IP Rating	IP20 (SGE series)				
Lithium Battery Communications	Standard protocol: PACE, PYLON Support dedicated charging curve for lithium battery				
Noise	Maximum noise 45dB Rated power condition $<50\text{dB}$ (ambient temperature 45 degrees) Under light load at night $<40\text{dB}$ (ambient temperature 25 degrees)				
Island Protection	Inclusion of isolated island protection				
Safety Standard	IEC/EN-62109-1, IEC/EN-62109-2				
WORK ENVIRONMENT					
Operating Temperature Range	$-20\sim 65^\circ\text{C}$ (use above 45°C derated)				
Relative Humidity	5~95% (surface no condensation)				
PHYSICAL					
Dimension D*W*H(mm) (With dust filter)	390*326*105(mm)			467*371*114(mm)	
weight (kg)	9.3kg		9.8kg		12kg

SOLAR INVERTER

SGM SERIES



KEY STRENGTHS



FEATURES

- High Efficiency & Smaller: Inverter/charging efficiency up to 95.5% (mainstream $\leq 93\%$), 30% smaller, low heat for longer life
- Smart Dual Outputs: Manages critical and general loads; custom 2nd output switch time & power-off voltage
- Smart Lithium Battery Mgmt: Activates protected batteries; adjusts charging curve by power to optimize charging
- Parallel Operation: Up to 9 units parallel; compatible with 3-phase/single-phase
- Smart Noise Control: Long-life fan (35-50dB); balances heat dissipation & quietness
- Standard broken-code LCD (current standard); optional 4.3-inch capacitive touch display
- Dustproof net: replaceable, washable; humanized cleaning cycle reminder
- Supports wireless upgrade (no network needed) for personalized customization
- Utility/PV self-start: Auto-starts when utility/PV connected (no manual restart after low-voltage battery shutdown)
- Recommended altitude $\leq 2000\text{m}$ (derated use at 2000m)
- Dual-CPU control, dual safety protection, built-in Gateway network module
- AC dual-input: One for mains power, one for generator dedicated interface
- Microgrid anti-backflow (optional): External CT + current sensor enables self-consumption, reducing wiring work
- Battery-Free Operation: Works with PV or mains power
- The optional WIFI module, support links SUNRAY Cloud for anytime/anywhere energy management & monitoring
- Bluetooth Direct Connect: Check device status via phone without network
- Standard 2 independent PV inputs; each MPPT tracking efficiency $>99.5\%$
- Battery communication: customizable protocol; supports RS485/CAN, lithium/lead-acid batteries
- Optimal operating temp: 25°C; max: 65°C (derated above 45°C)
- Smart fan control: reduces noise/air intake, extends dustproof net & device service life
- Max noise $<50\text{dB}$; $<40\text{dB}$ at night

MODEL	SGM486K5SH2	SGM4812K0SH2	SGM4814K0SH2	SGM4816K0SH2
Rated Output Power	6.5kw	12kw	14kw	16kw
Rated Output Current	28.5A	52A/60A	61A/70A	69.5/80A
Input Mode	Single phase			
Input Voltage Range	90-280Vac; or 170-280Vac			
Maximum AC Current Input	40A	65A	90A	100A
Change-over Time	10ms (narrow range), 20ms (wide range)			
Input Power Factor	> 0.99 > 0.9			
BATTERY MODE				
Output Voltage	220/230 ± 5 (Vac)			
Battery Discharge Current	140A	230A	270A	310A
Battery Charging Current	140A	230A	270A	310A
Battery Input Range	40-60 (VDC)			
Overvoltage Protection	63VDC			
Battery Discharge Conversion Efficiency	95%	95.2%		95.6%
Battery Charging Conversion Efficiency	95%	95.2%		95.6%
Overload	110%-125% 1min 125% -150% 30S $> 150\% 1\text{S}$			
Battery Type	Lead-acid batteries, lithium batteries, flooded lead-acid battery, user customization			
Dual-port Output	The second load can be set to start and stop mode: 1. User-defined battery voltage for shutdown and startup 2. Users can define the time interval to start and stop			
Peak Coefficient Of Output Current	1: 3			
Parallel Current Sharing	Imbalance $< 2\%$			
MPPT INPUT				
MPPT Quantity	1+1			
Maximum PV Input Current	18A+18A	18A+18A	26A+26A	32A+32A
Maximum PV Input Power	10kw	14.5kw	18kw	21kw
MPPT Starting Voltage	120VDC			
PV Input Voltage Range	60-500 (VDC)			
PV Best Input Voltage	360VDC			
MPPT Maximum Efficiency	99.5%			
PV inverter European efficiency	97.2%	97.3%		97.5%
PV Priority Supply	Priority charging			
PROTECTIVE FUNCTION				
Input Overvoltage Protection	280Vac			
Input Overvoltage Protection Recovery	270Vac			
Input Under-voltage Protection	90Vac (narrow range); 170Vac (wide range)			
Input Under-voltage Protection Recovery	100Vac (narrow range); 180Vac (wide range)			
Output Short Circuit Protection	5 power frequency cycles			
Fan Fault Protection	Fan fault protection function. When any fan is faulty, the power module has no output.			
COMMUNICATION FUNCTIONS				
PROJECT		REMARKS		
Lithium Battery	One RS485; one CAN (optional)			
WiFi/host Computer	Built-in WiFi + Bluetooth module, RS232			
Parallel Operation	CAN, up to nine units in parallel			
Remote Control	Bluetooth (can be set up and view inverter data remotely, no Internet connection required)			
OTHER				
Battery-free Mode	Compatible with lithium battery activation and no battery use			
IP Rating	IP54 (SGM series)			
Lithium Battery Communications	Standard protocol: PACE, PYLON Support dedicated charging curve for lithium battery			
Noise	Maximum noise 45dB Rated power condition $< 50\text{dB}$ (ambient temperature 45 degrees) Under light load at night $< 40\text{dB}$ (ambient temperature 25 degrees)			
Island Protection	Inclusion of isolated island protection			
Safety Standard	IEC/EN-62109-1, IEC/EN-62109-2			
WORK ENVIRONMENT				
Operating Temperature Range	$-20 \sim 65^\circ\text{C}$ (use above 45°C derated)			
Relative Humidity	5-95% (surface no condensation)			
PHYSICAL				
Dimension, D*W*H (mm)	440*378*130mm	482*409*129mm	595*472*130mm	
weight (kg)	9.5kg	14kg	21kg	

SOLAR INVERTER

SGP SERIES



KEY STRENGTHS



FEATURES

- High Efficiency & Smaller: Inverter/charging efficiency up to 95.5% (mainstream $\leq 93\%$), 30% smaller, low heat for longer life
- Smart Dual Outputs: Manages critical and general loads; custom 2nd output switch time & power-off voltage
- Smart Lithium Battery Mgmt: Activates protected batteries; adjusts charging curve by power to optimize charging
- Parallel Operation: Up to 6 units parallel; compatible with 3-phase/single-phase
- Smart Noise Control: Long-life fan (35-45dB); balances heat dissipation & quietness
- Standard broken-code LCD (current standard); optional 4.3-inch capacitive touch display
- Dustproof net: replaceable, washable; humanized cleaning cycle reminder
- Supports wireless upgrade (no network needed) for personalized customization
- Utility/PV self-start: Auto-starts when utility/PV connected (no manual restart after low-voltage battery shutdown)
- Recommended altitude $\leq 2000\text{m}$ (derated use at 2000m)
- Dual-CPU control, dual safety protection, built-in Gateway network module
- AC dual-input: One for mains power, one for generator dedicated interface
- Microgrid anti-backflow (optional): External CT + current sensor enables self-consumption, reducing wiring work
- Battery-Free Operation: Works with PV or mains power
- The optional WIFI module, support links SUNRAY Cloud for anytime/anywhere energy management & monitoring
- Bluetooth Direct Connect: Check device status via phone without network
- Standard 2 independent PV inputs; each MPPT tracking efficiency $>99.5\%$
- Battery communication: customizable protocol; supports RS485/CAN, lithium/lead-acid batteries
- Optimal operating temp: 25°C; max: 65°C (derated above 45°C)
- Smart fan control: reduces noise/air intake, extends dustproof net & device service life
- Max noise $<45\text{dB}$; $<40\text{dB}$ at night

MODEL	SGP485K0SH2-ES	SGP486K5SH2-ES	SGP486K5SH2	SGP489K0SH2	SGP4812K0SH2
Rated Output Power	5.0kw	6.5kw	6.5kw	9kw	12kw
Rated Output Current	21.7A	28.5A	28.5A	39.2A	52A
Input Mode	Single phase				
Input Voltage Range	170~280Vac				
Maximum AC Current Input	32A	40A	40A	55A	65A
Change-over Time	$<20\text{ms}$				
Input Power Factor	>0.99 >0.9				

BATTERY MODE					
Output Voltage	220/230/240 ± 5 (Vac)				
Battery Discharge Current	110A	140A	140A	190A	230A
Battery Charging Current	110A	140A	140A	190A	230A
Battery Input Range	40-60 (VDC)				
Overvoltage Protection	63VDC				
Battery Discharge Conversion Efficiency	95%	95.2%	95.2%	95.5%	
Battery Charging Conversion Efficiency	95%	95.2%	95.2%	95.5%	
Overload	110%-125% 1min 125% -150% 30S $>150\% 1\text{S}$				
Battery Type	Lead-acid batteries, lithium batteries, flooded lead-acid battery, user customization				
Dual-port Output	The second load can be set to start and stop mode: 1. User-defined battery voltage for shutdown and startup 2. Users can define the time interval to start and stop				
Peak Coefficient Of Output Current	1: 3				
Parallel Current Sharing	Imbalance $<2\%$				

MPPT INPUT					
MPPT Quantity	1		1+1		
Maximum PV Input Current	18A	24A	18A+18A	18A+18A	24A+24A
Maximum PV Input Power	7.5kw	8.5kw	10kw	12kw	16kw
MPPT Starting Voltage	120VDC				
PV Input Voltage Range	60-500 (VDC)				
PV Best Input Voltage	360VDC				
MPPT Maximum Efficiency	99.5%				
PV inverter European efficiency	97%	97%	97.3%		97.5%
PV Priority Supply	Priority charging				

PROTECTIVE FUNCTION	
Input Overvoltage Protection	280Vac
Input Overvoltage Protection Recovery	270Vac
Input Under-voltage Protection	90Vac (narrow range); 170Vac (wide range)
Input Under-voltage Protection Recovery	100Vac (narrow range); 180Vac (wide range)
Output Short Circuit Protection	5 power frequency cycles
Fan Fault Protection	Fan fault protection function. When any fan is faulty, the power module has no output.

COMMUNICATION FUNCTIONS		
PROJECT	REMARKS	
Lithium Battery	One RS485	One RS485; one CAN (optional)
WiFi/host Computer	External WiFi module (optional)	Built-in WiFi module (standard), RS232
Parallel Operation	Not supported	CAN, up to 6 units in parallel
Remote Control	Not supported	Bluetooth (can be set up and view inverter data remotely, no Internet connection required)

OTHER	
IP Rating	IP66 (SGP series)
Lithium Battery Communications	Standard protocol: PACE, PYLON Support dedicated charging curve for lithium battery
Noise	Maximum noise 45dB Rated power condition $<45\text{dB}$ (ambient temperature 45 degrees) Under light load at night $<40\text{dB}$ (ambient temperature 25 degrees)
Island Protection	Inclusion of isolated island protection
Safety Standard	IEC/EN-62109-1, IEC/EN-62109-2

WORK ENVIRONMENT	
Operating Temperature Range	-20~65°C (use above 45°C derated)
Relative Humidity	5~95% (surface no condensation)

PHYSICAL		
Dimension, D*W*H (mm)	540*350*188 (mm)	640*395*193 (mm)
weight (kg)	15kg	20kg

SOLAR INVERTER

SGP SERIES



NEW
New Launch

KEY STRENGTHS

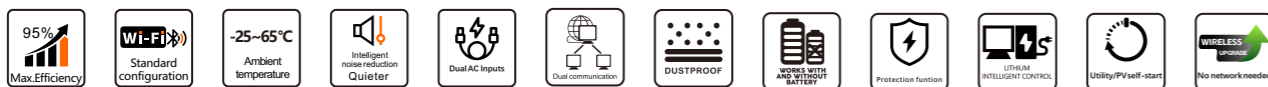

FEATURES

- High Efficiency & Smaller: Inverter/charging efficiency up to 95.5% (mainstream $\leq 93\%$), 30% smaller, low heat for longer life
- Smart Dual Outputs: Manages critical and general loads; custom 2nd output switch time & power-off voltage
- Smart Lithium Battery Mgmt: Activates protected batteries; adjusts charging curve by power to optimize charging
- Parallel Operation: Up to 6 units parallel; compatible with 3-phase/single-phase
- Smart Noise Control: Long-life fan (35-45dB); balances heat dissipation & quietness
- Standard broken-code LCD (current standard); optional 4.3-inch capacitive touch display
- Dustproof net: replaceable, washable; humanized cleaning cycle reminder
- Supports wireless upgrade (no network needed) for personalized customization
- Utility/PV self-start: Auto-starts when utility/PV connected (no manual restart after low-voltage battery shutdown)
- Recommended altitude $\leq 2000\text{m}$ (derated use at 2000m)
- Dual-CPU control, dual safety protection, built-in Gateway network module
- AC dual-input: One for mains power, one for generator dedicated interface
- Microgrid anti-backflow (optional): External CT + current sensor enables self-consumption, reducing wiring work
- Battery-Free Operation: Works with PV or mains power
- The optional WIFI module, support links SUNRAY Cloud for anytime/anywhere energy management & monitoring
- Bluetooth Direct Connect: Check device status via phone without network
- Standard 2 independent PV inputs; each MPPT tracking efficiency $>99.5\%$
- Battery communication: customizable protocol; supports RS485/CAN, lithium/lead-acid batteries
- Optimal operating temp: 25°C; max: 65°C (derated above 45°C)
- Smart fan control: reduces noise/air intake, extends dustproof net & device service life
- Max noise $<45\text{dB}$; $<40\text{dB}$ at night

MODEL	SGP4816K0TH2	SGP4818K0TH2
Rated Output Power	16kw	18kw
No-load power consumption in mains mode	$<70\text{W}$	
Input Mode	Three phase	
Input Voltage Range	205-240/357-417 (Vac)	
Maximum AC Input Current	30.3A	34.6A
Change-over Time	$<20\text{ms}$	
Input Power Factor	>0.99 >0.9	
Dual Input	Independent input interface for mains and generator	
BATTERY MODE		
Output Voltage	230/400 (Vac)	
Battery Discharge Current	300A	330A
Battery Charging Current	300A	330A
Battery Input Range	40-60 (VDC)	
Overvoltage Protection	60VDC	
Charging/discharging conversion Efficiency	96%	
Overload	110%-125% 30S 125% -150% 15S $>150\%1\text{S}$	
Battery Type	Lead-acid batteries, lithium batteries, vented lead-acid battery, user customization	
Dual-port Output	The second load can be set to start and stop mode: 1. User-defined battery voltage for shutdown and startup 2. Users can define the time interval to start and stop	
Peak Coefficient Of Output Current	1: 3	
Parallel Current Sharing	Imbalance $<2\%$	
Off-grid Mode Feed Power	$<30\text{VA}$	
MPPT INPUT		
MPPT Quantity	1+1+1	1+1+1
Maximum PV Input Current	18A+18A+18A	18A+18A+18A
Maximum PV Input Power	24kw	27kw
MPPT Starting Voltage	160VDC	
PV Input Voltage Range	150-1000 (VDC)	
PV Best Input Voltage	600VDC(Open circuit voltage (Voc) 800 V)	
MPPT Tracking Efficiency	$>99.5\%$	
PV inverter European efficiency	$>98\%$	
PV Priority Supply	Priority charging	
PROTECTIVE FUNCTION		
Input Overvoltage Protection	520Vac	
Input Overvoltage Protection Recovery	505Vac	
Input Under-voltage Protection	280Vac	
Input Under-voltage Protection Recovery	295Vac	
Output Short Circuit Protection	5 power frequency cycles	
Fan Fault Protection	Fan fault protection function. When any fan is faulty, the power module has no output.	
COMMUNICATION FUNCTIONS		
PROJECT		REMARKS
Lithium Battery	One RS485; one CAN (optional)	
WiFi/host Computer	Built in WiFi, Bluetooth module, RS232	
Parallel Operation	CAN, up to 6 units in parallel	
Human-machine Interface	Touch 4.3-inch color screen	
OTHER		
Battery-free Mode	Compatible with lithium battery activation and no battery use	
IP Rating	IP66 (SGP series)	
Lithium Battery Communications	Standard protocol: PACE, PYLON Support dedicated charging curve for lithium battery	
Noise	Maximum noise 45dB Rated power condition $<45\text{dB}$ (ambient temperature 45 degrees) Under light load at night $<40\text{dB}$ (ambient temperature 25 degrees)	
Island Protection	Inclusion of isolated island protection	
Safety Standard	IEC-62109	
WORK ENVIRONMENT		
Operating Temperature Range	$-20\sim65^\circ\text{C}$ (use above 45°C derated)	
Relative Humidity	5-95% (surface no condensation)	
PHYSICAL		
Dimension, D*W*H(mm) (including connectors)	715*478*265(mm)	
weight (kg)	47kg	48kg

WiFi Module



FEATURES

- Supports Wi-Fi 802.11b/g/n wireless standards
- Equipped with BL602 chip as the core processor, supporting Wi-Fi 802.11b/g/n protocol and BLE 5.0 protocol
- BL602 chip has a built-in low-power 32-bit RISC CPU and 276KB RAM
- Bluetooth Low Energy 5.0 and Bluetooth Mesh supported
- Supports RS232-to-Wi-Fi data transmission, with adaptive baud rates of 2400, 4800 and 9600
- Enables photovoltaic energy data upload, remote device management, and local data monitoring via Bluetooth-connected APP for users
- Wide power supply range: 5-15Vdc, 300mA peak

APP INTERFACE

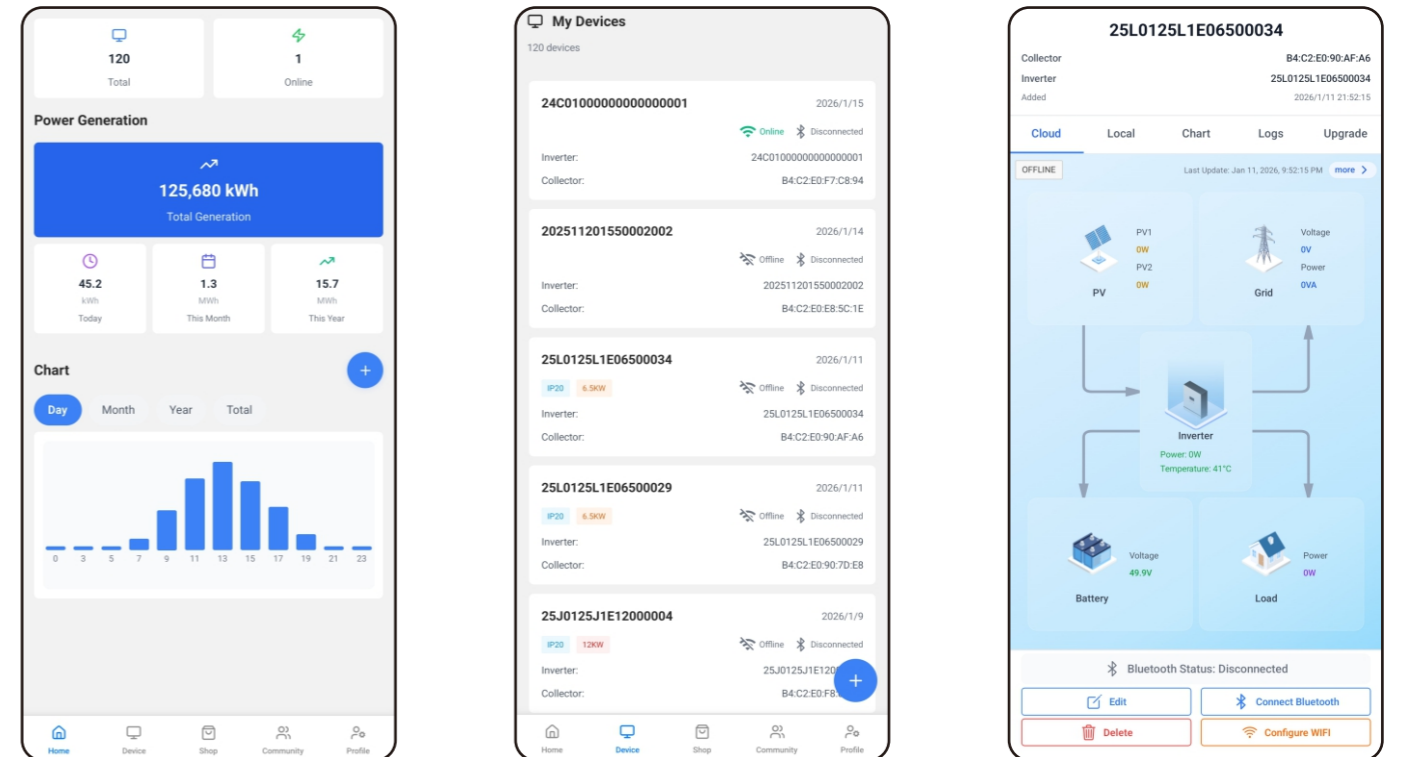

www.sumry-cloud.com
Operations Management Platform

MODEL	Wi-Fi PLUG-SR01
Dimension	67.6*22*12.2mm
Antenna Type	On-board Antenna
Frequency Range	2400-2484.5MHz
Operating Temperature	-25~ 65°C
Storage Temperature	-25~ 85°C
Power Supply Range	5~15Vdc, 300mAmax
Supported Interfaces	RS232, Wi-Fi, Bluetooth
Serial Port Speed	2400, 4800, 9600bps
Security	WPS/WEP/WPA/WPA2 Personal/WPA2 Enterprise/WPA3

OEM/ODM SERIES

ON/OFF GRID SOLAR INVERTER

SGE SERIES



4.5KW/6.5KW/9KW/12KW

SGP SERIES



5KW/6.5KW/9KW/12KW
16KW/18KW

MAX SERIES



8200W/8200VA
10200W/10200VA

MAX PRO SERIES



8200W/8200VA
10200W/10200VA

MAX-BL SERIES



8200W/8200VA
10200W/10200VA

OFF GRID SOLAR INVERTER

EP 2400L

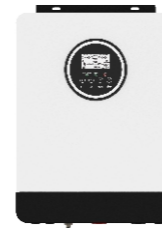

1200VA/1200W
2400VA/2400W

EP 4000L

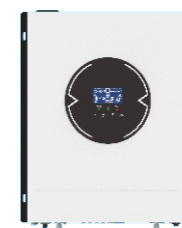

2000VA/2000W
3500VA/3500W

EP 4200H



2300VA/2300W
4200VA/4200W

EP 4200H PRO

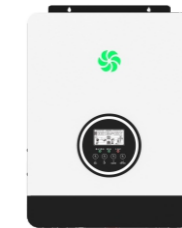

2300VA/2300W
4200VA/4200W

SP SERIES



2500VA/2500W
3500VA/3500W

NM-ECO-II SERIES



4200W/4200VA
6200W/6200VA

NM-ECO-LV SERIES



3600W/3600VA

NM-ECO PRO SERIES



3600W/3600VA
4200W/4200VA
6200W/6200VA

ECO-II-M SERIES



4200W/4200VA
6200W/6200VA

ECO-II-M PLUS SERIES



4600W/4600VA
6600W/6600VA

RS SERIES

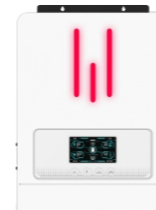

2200VA/1800W
3200VA/3000W
4200VA/3800W
7000VA/6200W

LS SERIES

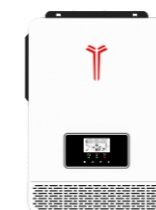

2000W/2000VA
3200W/3200VA

NML SERIES



2000VA/1600W
3200VA/3000W

NMS SERIES



1000W/1000VA
1500W/1500VA

ECO-BL SERIES



4200W/4200VA
6200W/6200VA

NM-V plus SERIES



4500W/4500VA
6500W/6500VA

MPS-VX SERIES



4500W
6500W

SCE SERIES



4.5KW/4.5KVA
6.5KW/6.5KVA
10KW/10KVA

SGM SERIES



6.5KW/6.5KVA
12KW/12KVA
14KW/14KVA
16KW/16KVA

POWER INVERTER

TITAN SERIES



3000W
5000W

MPPT CHARGER

XMC SERIES

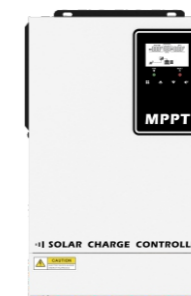

140A
80A